

WORX

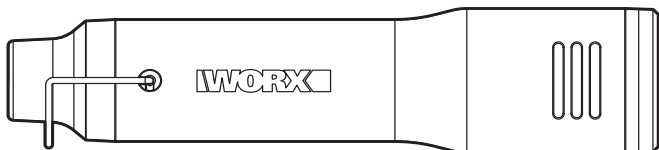

MAKERX™

SAFETY AND OPERATING MANUAL ORIGINAL INSTRUCTIONS

20V Cordless Mini Heat Gun

**WX743
WX743.X**

PRODUCT SAFETY

GENERAL SAFETY WARNINGS

 **WARNING: Read all safety warnings and instructions.** *Failure to follow all instructions listed below may result in electric shock, fire and/or serious injury.*

Save all warnings and instructions for future reference.

This appliance can be used by children aged from 8 years and above and persons with reduced physical, sensory or mental capabilities or lack of experience and knowledge if they have been given supervision or instruction concerning use of the appliance in a safe way and understand the hazards involved. Children shall not play with the appliance. Cleaning and user maintenance shall not be made by children without supervision.

WARNING: For the purposes of recharging the battery, only use the detachable supply unit provided with this appliance.

ADDITIONAL SAFETY RULES FOR HEAT GUNS

WARNING: This tool must be placed on its stand when not in use.

A fire may result if the appliance is not used with

care, therefore

- be careful when using the appliance in places where there are combustible materials;
- do not apply to the same place for a long time;
- do not use in presence of an explosive atmosphere;
- be aware that heat may be conducted to combustible materials that are out of sight;
- place the appliance on its stand after use and allow it to cool down before storage;
- do not leave the appliance unattended when it is switched on.

EN

4

SAFETY WARNINGS FOR BATTERY PACK

a) Do not dismantle, open or shred cells or battery pack.









b) Do not short-circuit a battery pack. Do not store battery packs haphazardly in a box or drawer where they may short-circuit each other or be short-circuited by conductive materials. When battery pack is not in use, keep it away from other metal objects, like paper clips, coins, keys, nails, screws or other small metal objects, that can make a connection from one terminal

to another. Shorting the battery terminals together may cause burns or a fire.

- c) Do not expose battery pack to heat or fire. Avoid storage in direct sunlight.**
- d) Do not subject battery pack to mechanical shock.**
- e) In the event of battery leaking, do not allow the liquid to come into contact with the skin or eyes. If contact has been made, wash the affected area with copious amounts of water and seek medical advice.**
- f) Seek medical advice immediately if a cell or battery pack has been swallowed.**
- g) Keep battery pack clean and dry.**
- h) Wipe the battery pack terminals with a clean dry cloth if they become dirty.**
- i) Battery pack needs to be charged before use. Always refer to this instruction and use the correct charging procedure.**
- j) Do not maintain battery pack on charge when not in use.**
- k) After extended periods of storage, it may be necessary to charge and discharge the battery pack several times to obtain maximum performance.**

- l) Recharge only with the charger specified by Worx. Do not use any charger other than that specifically provided for use with the equipment.**
- m) Do not use any battery pack which is not designed for use with the equipment.**
- n) Keep battery pack out of the reach of children.**
- o) Retain the original product literature for future reference.**
- p) Remove the battery from the equipment when not in use.**
- q) Dispose of properly.**
- r) Do not mix cells of different manufacture, capacity, size or type within a device.**
- s) Do not remove battery pack from its original packaging until required for use.**
- t) Observe the plus (+) and minus (–) marks on the battery and ensure correct use.**

SYMBOLS

	Read operator's manual
	Warning
	Wear eye protection
	Wear protective gloves
	Do not burn
	Batteries may enter water cycle if disposed improperly, which can be hazardous for ecosystem. Do not dispose of waste batteries as unsorted municipal waste.
 Li-Ion	Li-Ion battery. This product has been marked with a symbol relating to 'separate collection' for all battery packs and battery pack. It will then be recycled or dismantled in order to reduce the impact on the environment. Battery packs can be hazardous for the environment and for human health since they contain hazardous substances.
 	Waste electrical products must not be disposed of with household waste. Please recycle where facilities exist. Check with your local authorities or retailer for recycling advice

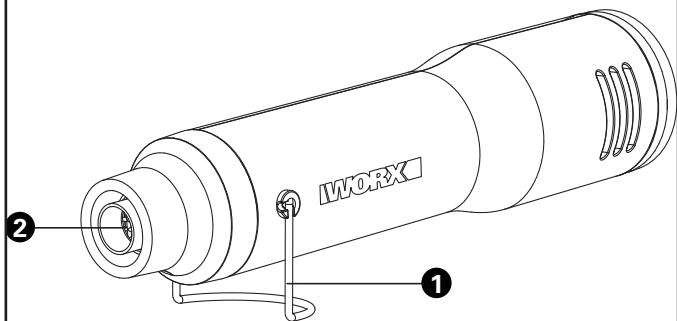

COMPONENT LISTS

1. TRESTLE

2. NOZZLE





Not all the accessories illustrated or described are included in standard delivery.

TECHNICAL DATA

	WX743 WX743.X*
Rated voltage	20 V  Max**
Power input	200 W
Max temperature	260 °C
Battery type	Lithium battery
Machine weight (bare tool)	210 g

* X=1-99, A-Z, M1-M9 there are only used for different customers, there are no safe relevant changes between these models.

**Voltage measured without workload. Initial battery voltage reaches maximum of 20 volts. Nominal voltage is 18 volts.

Category	Model	Capacity
20V Hub/HubX	WA7160	Input: 20 V  10 A Max. Output: 20 V  10 A Max.
	WA7161	Input: 20 V  10 A Max. Output: 20 V  10 A Max. Or Output: 5 V  2 A (USB port)

We recommend that you purchase your accessories from the same store that sold you the tool. Refer to the accessory packaging for further details. Store personnel can assist you and offer advice.

MakerX series tools and 20V Hub/HubX are specially designed to work together, so do not attempt to use any other devices.

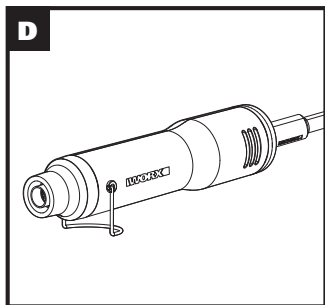
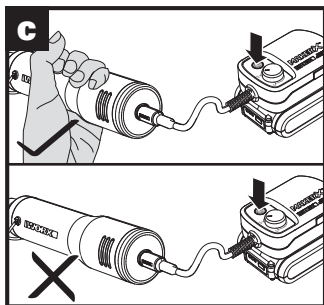
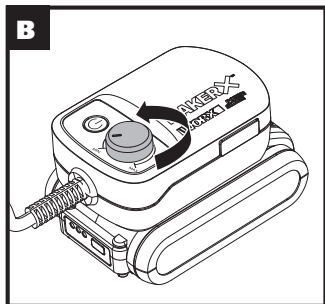
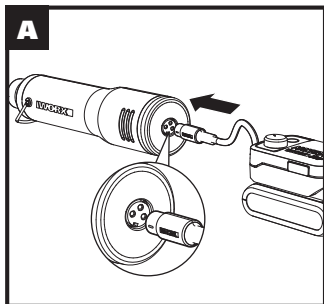

OPERATING INSTRUCTIONS



NOTE: Before using the tool, read the instruction book carefully.

ASSEMBLY AND OPERATION

1. Connect the mini heat gun to the hub. (See Fig. A)



WARNING: Before operation, make sure the speed control button on the hub is at the "Min" position. (See Fig. B)

2. Confirm the speed control button is set to "Min". Grasp the tool by the grip. Press the on/off switch on the hub to start the machine. (See Fig. C)

Note: The air speed is fixed, and can not be adjusted by the speed control button on the hub.

3. Fold down the trestle to keep the heat gun from burning surfaces. (See Fig. D)

Note: After usage, press the on/off switch on the hub to turn off the machine and disconnect it from the hub. Keep the machine in an open environment with no objects around to let the machine cool. (Shown as Fig. D)



Warning: The air temperature can reach 260°C in seconds. Do not use the heat gun more than 10 minutes continuously. Do not aim the nozzle at any part of the body. The nozzle will get extremely hot and becomes a burn risk. Do not touch the nozzle when hot. Do not use any object to cover the nozzle. Never operate the heat gun while people, especially young children are nearby.

EN

11

MAINTENANCE

Remove the battery pack from the tool before carrying out any adjustment, servicing or maintenance.

Your tool requires no additional lubrication or maintenance.

There are no user serviceable parts in your power tool. Never use water or chemical cleaners to clean your power tool. Wipe clean with a dry cloth. Always store your power tool in a dry place. Keep the motor ventilation slots clean. Keep all working controls free of dust. Occasionally you may see sparks through the ventilation slots. This is normal and will not damage your power tool.

ENVIRONMENTAL PROTECTION



Waste electrical products must not be disposed of with household waste. Please recycle where facilities exist. Check with your local authorities or retailer for recycling advice.

DECLARATION OF CONFORMITY

We,
Positec Germany GmbH
Grüner Weg 10, 50825 Cologne, Germany

On behalf of Positec declare that the product
Description **Battery operated mini heat gun**
Type **WX743 WX743.X (743-designation of machinery, representative of heat gun)**
Function **Heating**

Complies with the following Directives:
2011/65/EU&(EU)2015/863
2014/30/EU

Standards conform to
EN 60335-1
EN 60335-2-45
EN 62233
EN 55014-1
EN 55014-2

EN

12



2020/07/22
Allen Ding
Deputy Chief Engineer, Testing & Certification
Positec Technology (China) Co., Ltd
18, Dongwang Road, Suzhou Industrial
Park, Jiangsu 215123, P. R. China

DECLARATION OF CONFORMITY

We,
Positec Power Tools (Europe) Ltd,
PO Box 6242, Newbury, RG14 9LT, UK

On behalf of Positec declare that the product
Description **Battery operated mini heat gun**
Type **WX743 WX743.X (743-designation of machinery, representative of heat gun)**
Function **Heating**

Complies with the following Directives:
Electromagnetic Compatibility Regulations 2016
The Restriction of the Use of Certain Hazardous Substances in Electrical and Electronic Equipment Regulations

Standards conform to
BS EN 60335-1
BS EN 60335-2-45
BS EN 62233
BS EN 55014-1
BS EN 55014-2

EN

13



2020/07/22
Allen Ding
Deputy Chief Engineer, Testing & Certification
Positec Technology (China) Co., Ltd
18, Dongwang Road, Suzhou Industrial
Park, Jiangsu 215123, P. R. China

WORX

you've got the power

After-sales Service and Application

At www.worx.com you can order spare parts or arrange the collection of a product in need of servicing or repair.

Tel. Service: 0345 202 9679

E-Mail: customerservices@worxtools.com

www.worx.com

Copyright © 2020, Positec. All Rights Reserved.